

LOW DROPOUT VOLTAGE REGULATOR

■ GENERAL DESCRIPTION

The NJM2855 is a 3-terminal low dropout voltage regulator. Advanced Bipolar technology achieves low noise, high ripple rejection. It delivers up to 5V/1A output power with the maximum input voltage of 10V. The NJM2855 is suitable for various applications such as portable / consumer devices.

■ PACKAGE OUTLINE

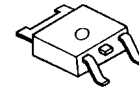

NJM2855DL1

■ FEATURES

- High Ripple Rejection 75dB typ. (f=1kHz,Vo=3V Version)
- Output Noise Voltage Vno=45μVrms typ.
- Output capacitor with 2.2μF ceramic capacitor (Vo≥2.7V)
- Output Current Io (max.)=1A
- High Precision Output Vo±1.0%
- Low Dropout Voltage 0.20V typ. (Io=600mA)
- Internal Short Circuit Current Limit
- Internal Thermal Overload Protection
- Bipolar Technology
- Package Outline TO-252-3

■ PIN CONFIGURATION

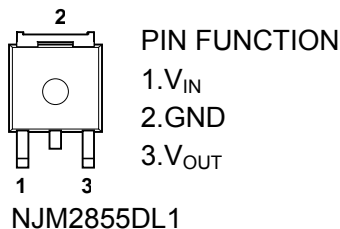

■ EQUIVALENT CIRCUIT

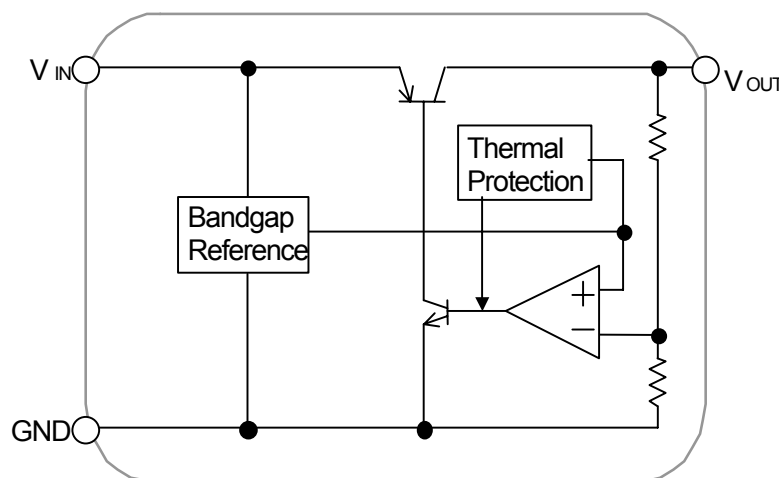

■ OUTPUT VOLTAGE RANK LIST

The WHITE column shows applicable Voltage Rank(s)

Device Name	V _{out}	Device Name	V _{out}
NJM2855DL1-15	1.5V	NJM2855DL1-35	3.5V
NJM2855DL1-16	1.6V	NJM2855DL1-36	3.6V
NJM2855DL1-17	1.7V	NJM2855DL1-37	3.7V
NJM2855DL1-18	1.8V	NJM2855DL1-38	3.8V
NJM2855DL1-19	1.9V	NJM2855DL1-39	3.9V
NJM2855DL1-02	2.0V	NJM2855DL1-04	4.0V
NJM2855DL1-21	2.1V	NJM2855DL1-41	4.1V
NJM2855DL1-22	2.2V	NJM2855DL1-42	4.2V
NJM2855DL1-23	2.3V	NJM2855DL1-43	4.3V
NJM2855DL1-24	2.4V	NJM2855DL1-44	4.4V
NJM2855DL1-25	2.5V	NJM2855DL1-45	4.5V
NJM2855DL1-26	2.6V	NJM2855DL1-46	4.6V
NJM2855DL1-27	2.7V	NJM2855DL1-47	4.7V
NJM2855DL1-28	2.8V	NJM2855DL1-48	4.8V
NJM2855DL1-29	2.9V	NJM2855DL1-49	4.9V
NJM2855DL1-03	3.0V	NJM2855DL1-05	5.0V
NJM2855DL1-31	3.1V		
NJM2855DL1-32	3.2V		
NJM2855DL1-33	3.3V		
NJM2855DL1-34	3.4V		

■ ABSOLUTE MAXIMUM RATINGS (Ta=25°C)

PARAMETER	SYMBOL	RATINGS	UNIT
Input Voltage	V_{IN}	+10	V
Power Dissipation	P_D	1190(*1)	mW
Operating Temperature	T_{opr}	-40 ~ +85	°C
Storage Temperature	T_{stg}	-40 ~ +150	°C

(*1): Mounted on glass epoxy board based on EIA/JEDEC. (114.3x76.2x1.6mm: 2Layers, copper area 100mm²)

■ OPERATING VOLTAGE

$V_{IN}=+2.5V \sim +8V$ (In case of $V_o < 2.3V$ version)

■ ELECTRICAL CHARACTERISTICS

($V_{IN}=V_o+1V$, $C_{IN}=0.33\mu F$, $C_o=2.2\mu F$ ($1.7V < V_o \leq 2.6V$: $4.7\mu F$, $V_o \leq 1.7V$: $10\mu F$), $T_a=25^\circ C$)

PARAMETER	SYMBOL	TEST CONDITION	MIN.	TYP.	MAX.	UNIT
Output Voltage	V_o	$I_o=30mA$	-1.0%	-	+1.0%	V
Input Voltage	V_{IN}		-	-	8	V
Quiescent Current	I_Q	$I_o=0mA$	-	400	600	μA
Output Current	I_o	$V_o-0.3V$	1000	1300	-	mA
Line Regulation	$\Delta V_o / \Delta V_{IN}$	$V_{IN}=V_o+1V \sim V_o+6V (V_o \leq 2V)$, $V_{IN}=V_o+1V \sim 8V (V_o > 2V)$, $I_o=30mA$	-	-	0.10	%/V
Load Regulation	$\Delta V_o / \Delta I_o$	$I_o=0 \sim 1A$	-	-	0.004	%/mA
Dropout Voltage(*2)	ΔV_{I-O}	$I_o=600mA$	-	0.20	0.28	V
Ripple Rejection	RR	$e_{in}=200mV_{rms}$, $f=1kHz$, $I_o=10mA$ $V_o=3.0V$ Version	-	75	-	dB
Average Temperature Coefficient of Output Voltage	$\Delta V_o / \Delta T_a$	$T_a=0 \sim 85^\circ C$, $I_o=10mA$	-	± 50	-	ppm/°C
Output Noise Voltage	V_{NO}	$f=10Hz \sim 80kHz$, $I_o=10mA$, $V_o=3.0V$ Version(*3)	-	45	-	μV_{rms}
Input Voltage	V_{IN}		-	-	8	V

(*2): The output voltage excludes under 2.1V.

(*3): $V_o > 2.0V$: $V_{IN}=V_o+1V$, $V_o \leq 2.0V$: $V_{IN}=3.0V$

The above specification is a common specification for all output voltages.

Therefore, it may be different from the individual specification for a specific output voltage.

■ POWER DISSIPATION vs. AMBIENT TEMPERATURE

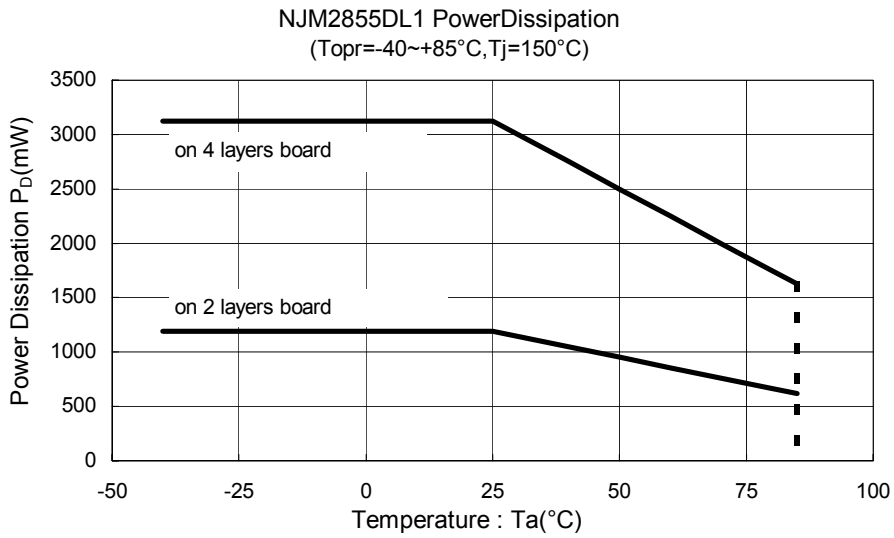

■ TEST CIRCUIT

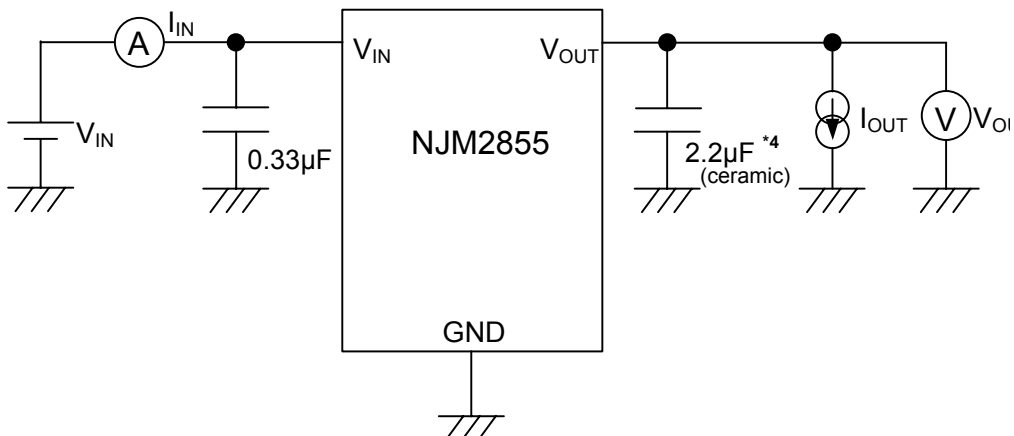

*4 1.7V < V_o ≤ 2.6V version: C_o = 4.7µF (ceramic)
 V_o ≤ 1.7V version: C_o = 10µF (ceramic)

■ TYPICAL APPLICATION

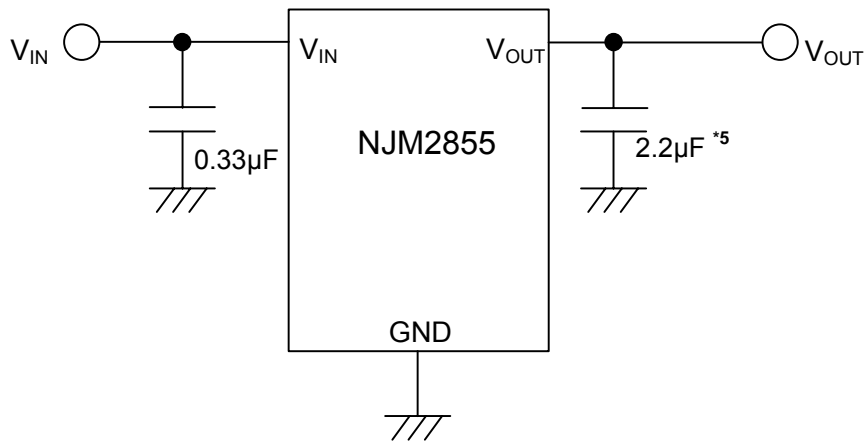

*5 1.7V < V_o ≤ 2.6V version: C_o = 4.7µF
 V_o ≤ 1.7V version: C_o = 10µF

***Input Capacitance C_{IN}**

Input Capacitance C_{IN} is required to prevent oscillation and reduce power supply ripple for applications with high power supply impedance or a long power supply line.

Use the C_{IN} value of $0.33\mu\text{F}$ greater to avoid the problem.

C_{IN} should connect between GND and V_{IN} as short as possible.

***Output Capacitance C_o**

Output capacitor (C_o) is required for a phase compensation of the internal error amplifier. The capacitance and the equivalent series resistance (ESR) influence stability of the regulator.

If use a smaller C_o , it may cause excess output noise or oscillation of the regulator due to lack of the phase compensation. Therefore, use C_o with the recommended capacitance or greater value and connect between V_o terminal and GND terminal with minimal wiring.

The recommended capacitance depends on the output voltage. Low voltage regulator requires greater value of the C_o . Thus, check the recommended capacitance for each output voltage.

Use of a greater C_o reduces output noise and ripple output, and also improves transient response of the output voltage against rapid load change.

This product is designed to work with any capacitor including a low ESR capacitor for the C_o ; however, refer "Equivalent Series Resistance vs. Output Current" and choose suitable capacitor.

■ TYPICAL CHARACTERISTICS

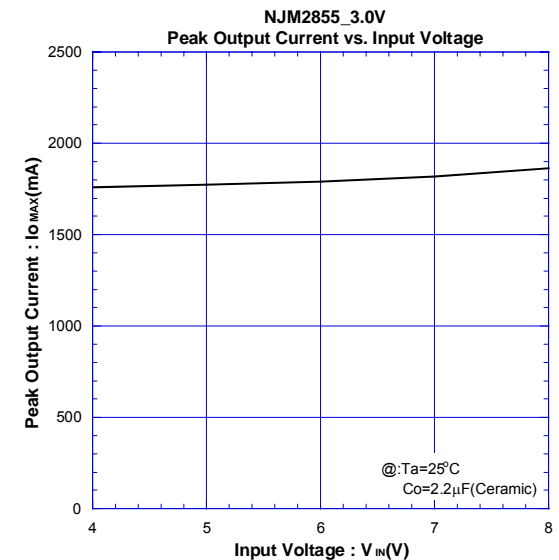
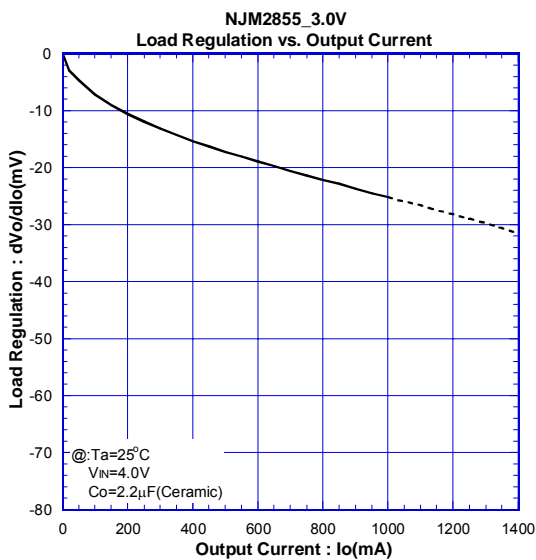
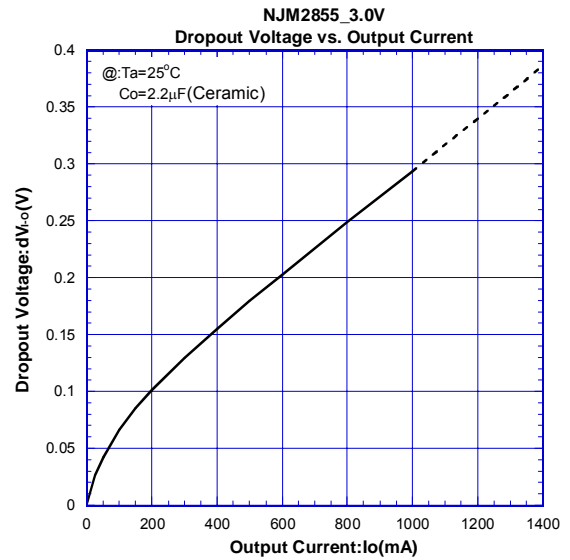
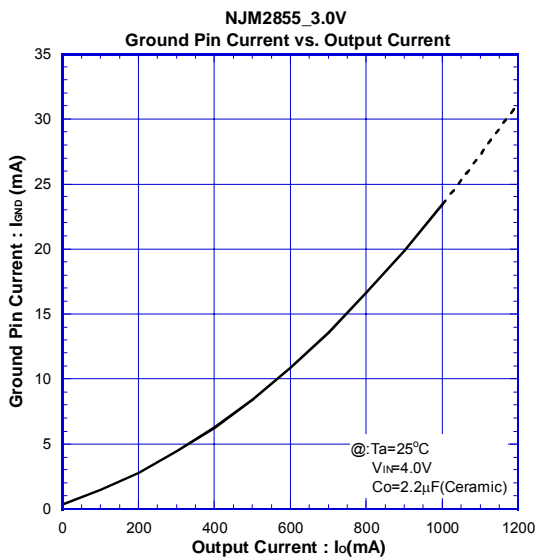
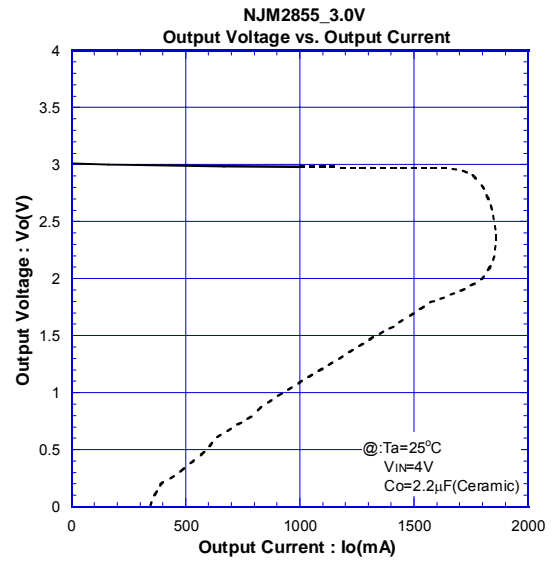
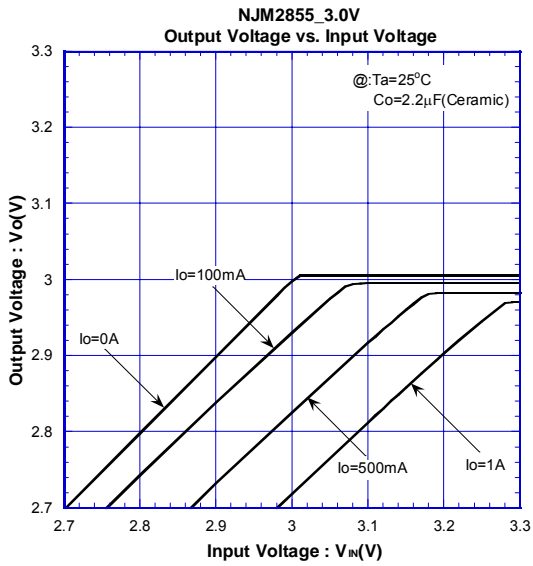

■ TYPICAL CHARACTERISTICS

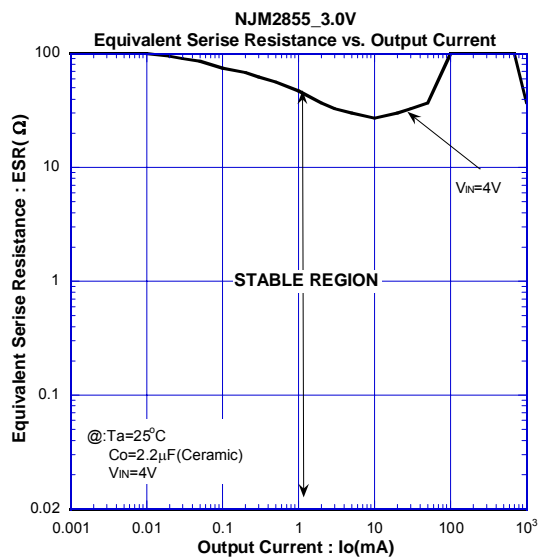
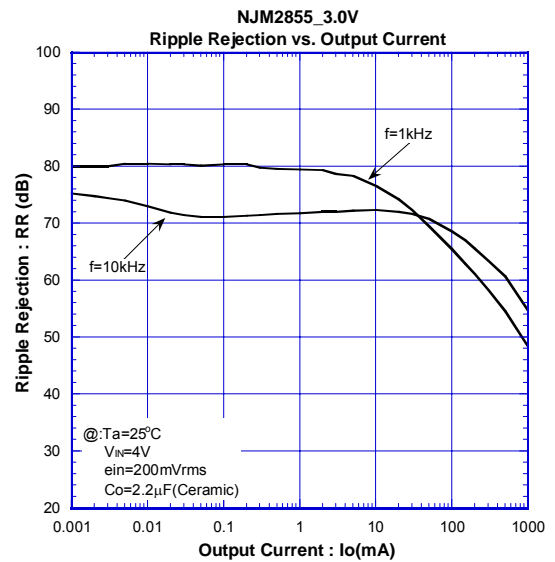
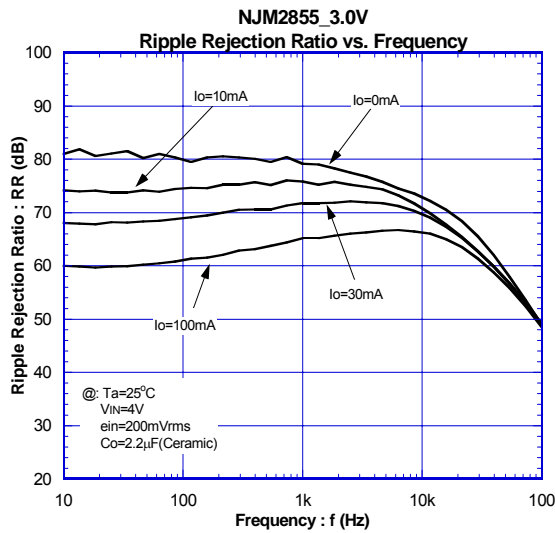
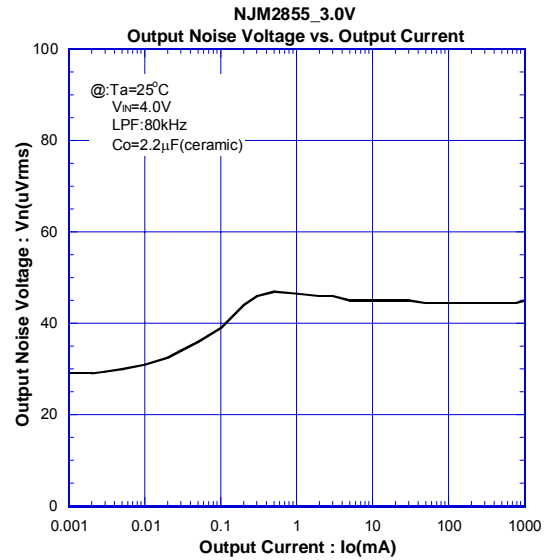
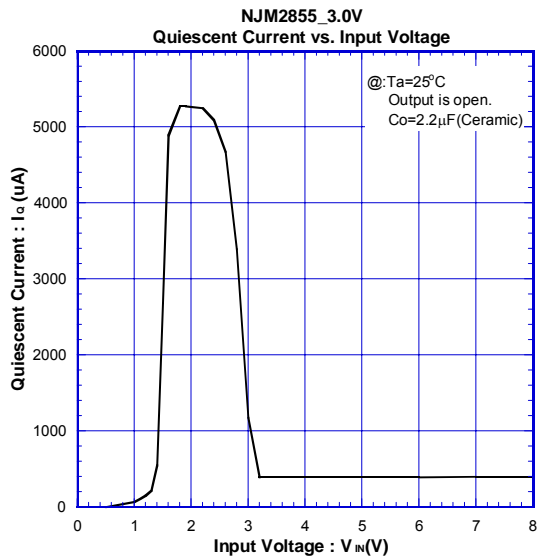

■ TYPICAL CHARACTERISTICS

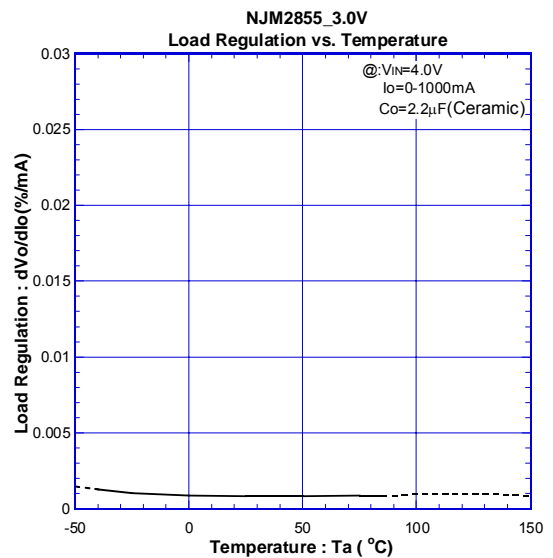
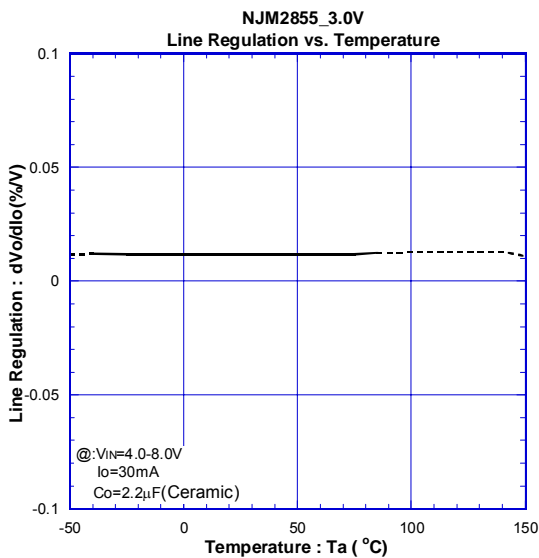
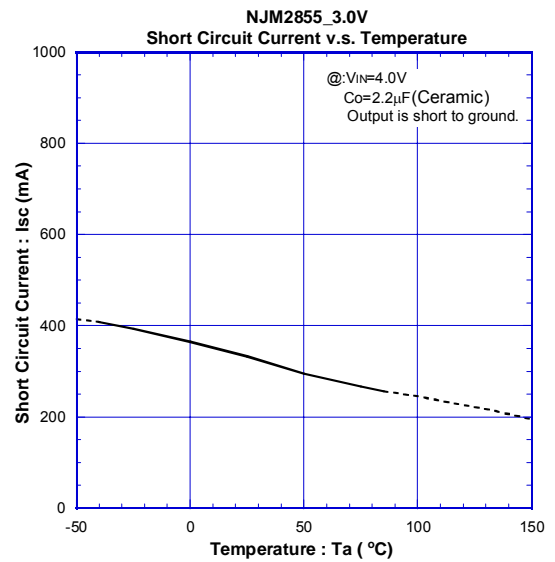
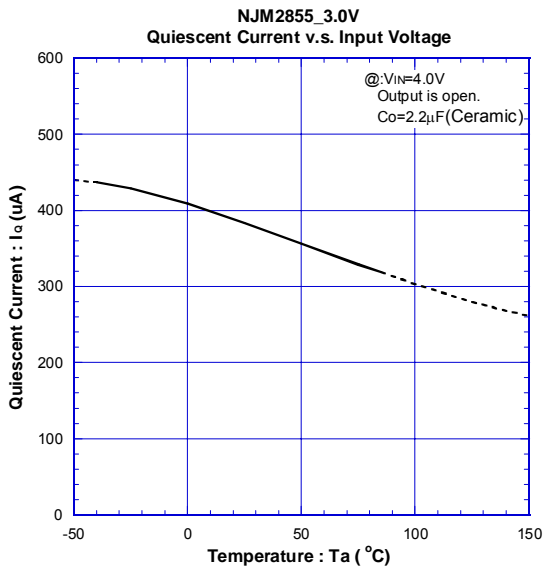
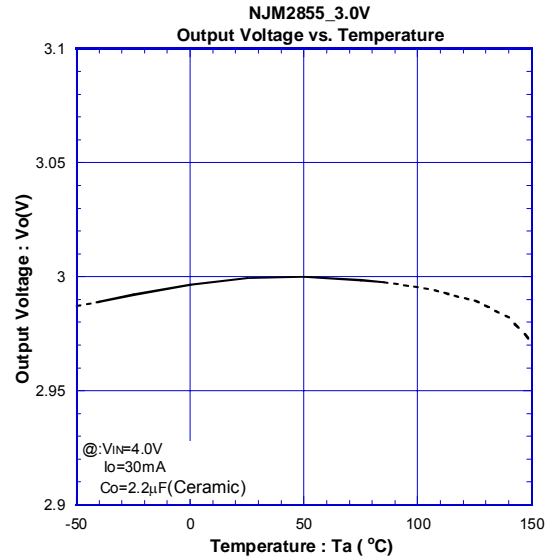
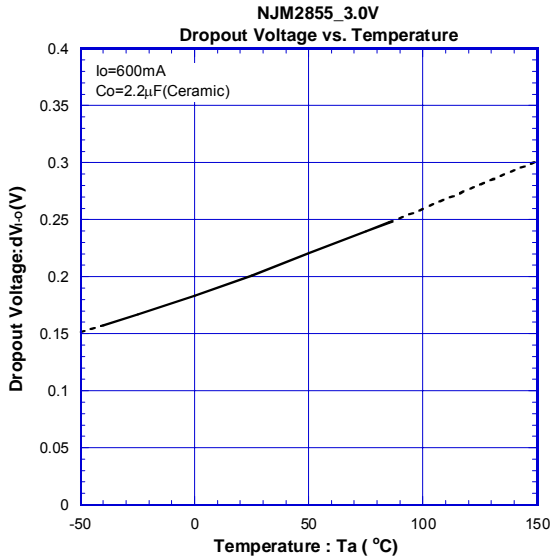

■ TYPICAL CHARACTERISTICS

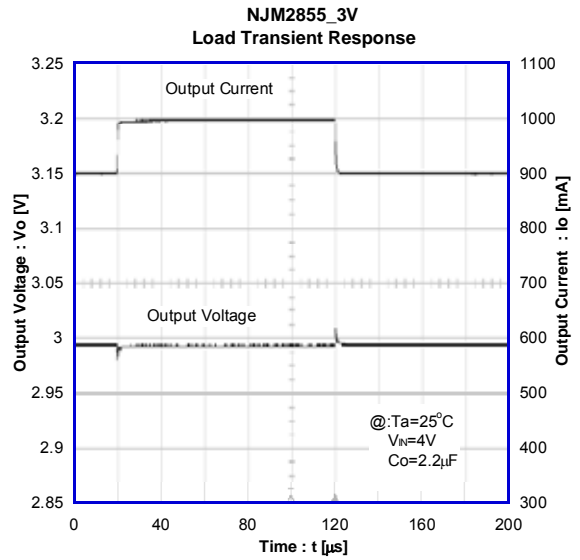
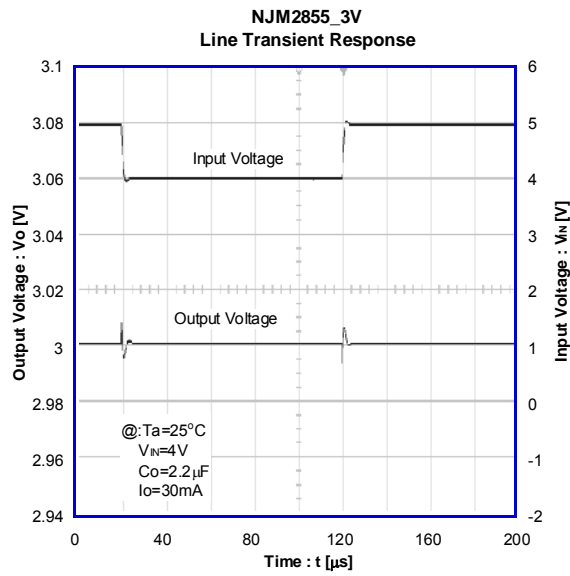
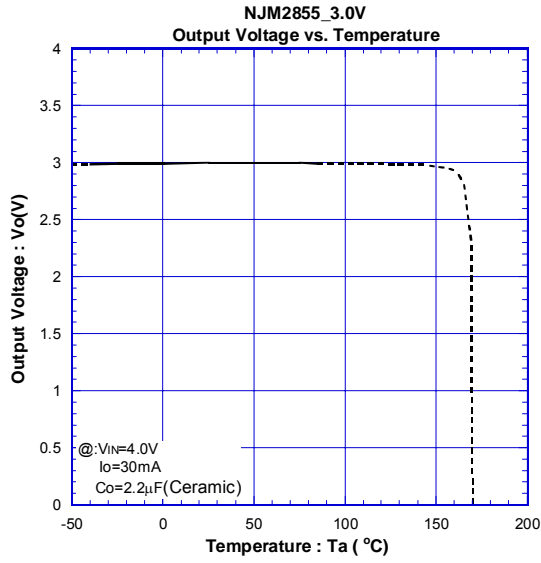

[CAUTION]

The specifications on this databook are only given for information, without any guarantee as regards either mistakes or omissions. The application circuits in this databook are described only to show representative usages of the product and not intended for the guarantee or permission of any right including the industrial rights.